

Preliminary Drawing for R. P. Adams Model 4" GP-508-HD-PC ASME Steam Filter 200 PSIG Design Pressure

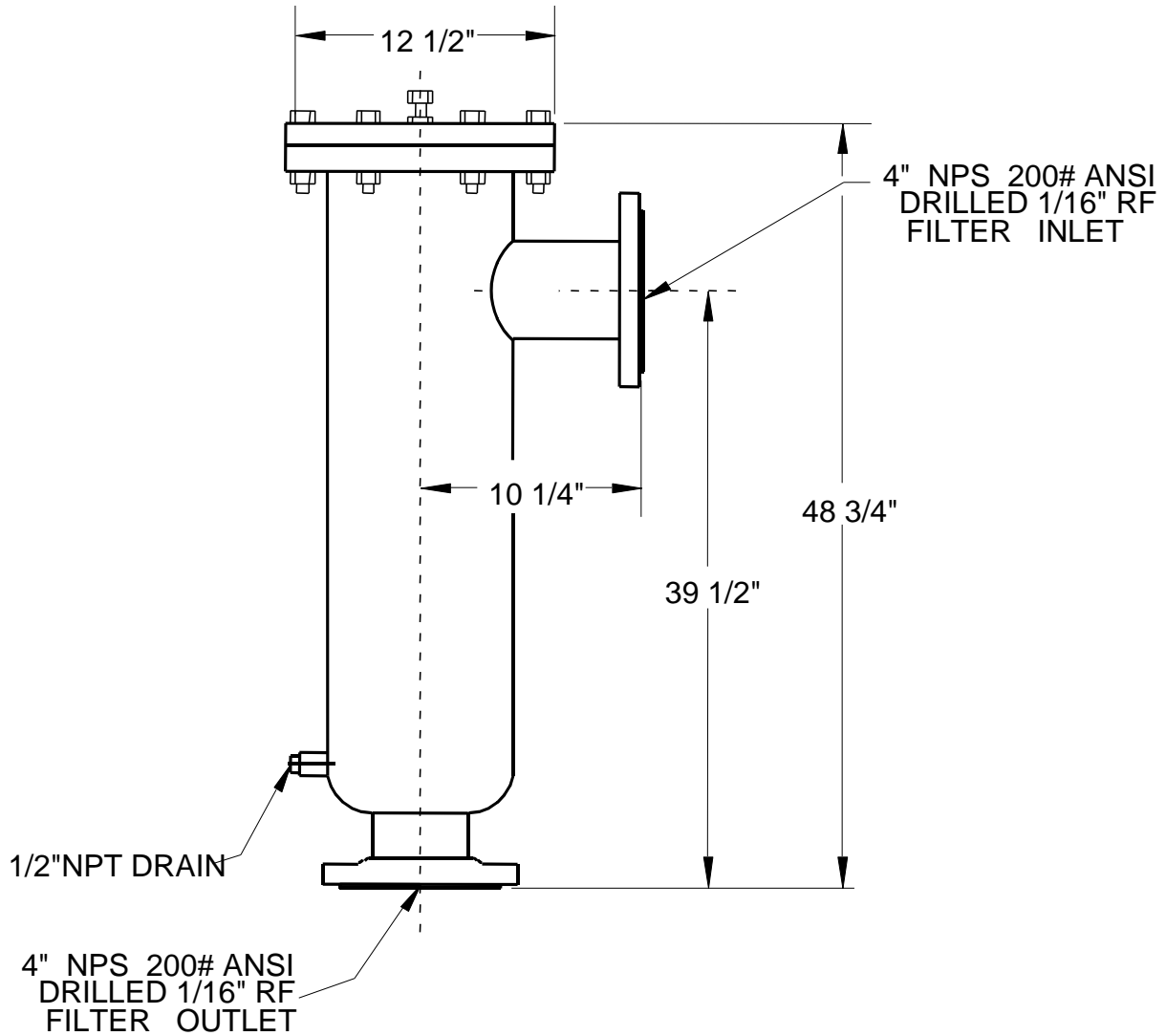

Notes: This is a preliminary drawing and should not be used for construction purposes.

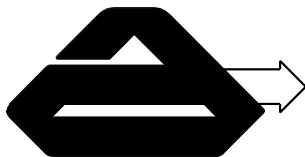

R. P. Adams
P. O. Box 963
Buffalo, NY 14240-0963
Phone: (716) 877-2608
Fax: (716) 877-9385
Email: info@rpadams.com

Date:
Proposal No.:
Customer:
Address:
Submitted by: