

# Preliminary Drawing for R. P. Adams Model 2" GP-132-HD-PS Gas Filter 300 PSIG Design Pressure

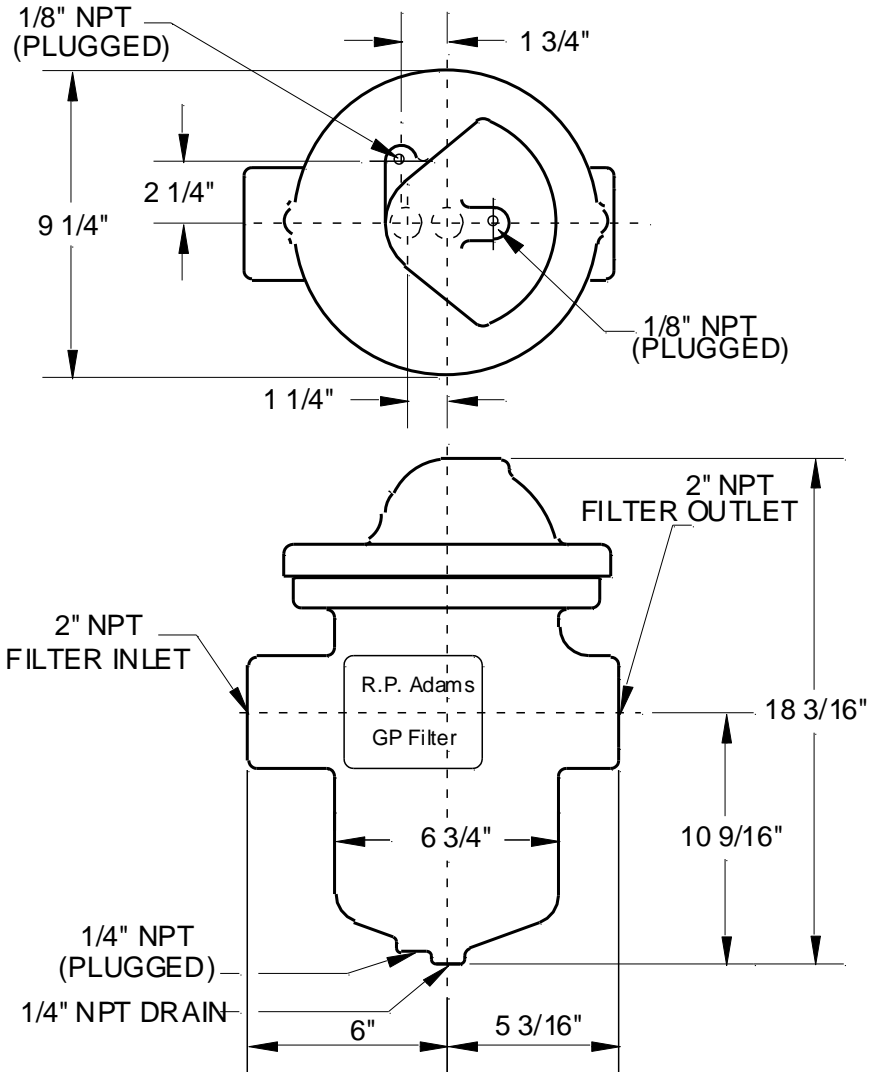

Notes: This is a preliminary drawing and should not be used for construction purposes.



**R. P. Adams**  
**P. O. Box 963**  
**Buffalo, NY 14240-0963**  
**Phone: (716) 877-2608**  
**Fax: (716) 877-9385**  
**Email: info@rpadams.com**

<b>Date:</b>
<b>Proposal No.:</b>
<b>Customer:</b>
<b>Address:</b>
<b>Submitted by:</b>